

INSTRUCTION MANUAL

---

**DEWALT**®

---

**D28065-XE, D28065N-XE, D28115-XE, D28115N-XE**

HEAVY-DUTY ANGLE GRINDERS



### **Definitions: Safety Guidelines**

The definitions below describe the level of severity for each signal word. Please read the manual and pay attention to these symbols.

**⚠DANGER:** Indicates an imminently hazardous situation which, if not avoided, **will** result in **death or serious injury**.

**⚠WARNING:** Indicates a potentially hazardous situation which, if not avoided, **could** result in **death or serious injury**.

**⚠CAUTION:** Indicates a potentially hazardous situation which, if not avoided, **may** result in **minor or moderate injury**.

**CAUTION:** Used without the safety alert symbol indicates a potentially hazardous situation which, if not avoided, **may** result in **property damage**.

IF YOU HAVE ANY QUESTIONS OR COMMENTS ABOUT THIS OR ANY DEWALT TOOL, CALL US AT: **1800 654 155** (Aust) or **09 259 1111** (NZ).

## **SAFETY INSTRUCTIONS FOR POWER TOOLS**

When using power tools, always observe the safety regulations applicable in your country to reduce the risk of fire, electric shock and personal injury. Read the following safety instructions before attempting to operate this product. Keep these instructions in a safe place.

### **General Safety Rules**

**⚠WARNING! Read all instructions.** Failure to follow all instructions listed below may result in electric shock, fire and/or serious injury. The term "power tool" in all of the warnings listed below refers to your mains operated (corded) power tool or battery operated (cordless) power tool.

## **SAVE THESE INSTRUCTIONS**

### **1. WORK AREA**

- a. **Keep work area clean and well lit.** Cluttered and dark areas invite accidents.

- b. **Do not operate power tools in explosive atmospheres, such as in the presence of flammable liquids, gases or dust.** Power tools create sparks which may ignite the dust or fumes.
- c. **Keep children and bystanders away while operating a power tool.** Distractions can cause you to lose control.

### **2. ELECTRICAL SAFETY**

- a. **Power tool plugs must match the outlet. Never modify the plug in any way. Do not use any adapter plugs with earthed (grounded) power tools.** Unmodified plugs and matching outlets will reduce risk of electric shock.
- b. **Avoid body contact with earthed or grounded surfaces such as pipes, radiators, ranges and refrigerators.** There is an increased risk of electric shock if your body is earthed or grounded.
- c. **Do not expose power tools to rain or wet conditions.** Water entering a power tool will increase the risk of electric shock.
- d. **Do not abuse the cord. Never use the cord for carrying, pulling or unplugging the power tool. Keep cord away from heat, oil, sharp edges or moving parts.** Damaged or entangled cords increase the risk of electric shock.
- e. **When operating a power tool outdoors, use an extension cord suitable for outdoor use.** Use of a cord suitable for outdoor use reduces the risk of electric shock.

### **3. PERSONAL SAFETY**

- a. **Stay alert, watch what you are doing and use common sense when operating a power tool. Do not use a power tool while you are tired or under the influence of drugs, alcohol or medication.** A moment of inattention while operating power tools may result in serious personal injury.
- b. **Use safety equipment. Always wear eye protection.** Safety equipment such as dust mask, non-skid safety shoes, hard hat, or hearing protection used for appropriate conditions will reduce personal injuries.
- c. **Avoid accidental starting. Ensure the switch is in the off position before plugging in.** Carrying power tools with your finger on the switch or plugging in power tools that have the switch on invites accidents.
- d. **Remove any adjusting key or wrench before turning the power tool on.** A wrench or a key left attached to a rotating part of the power tool may result in personal injury.

- e. **Do not overreach. Keep proper footing and balance at all times.** This enables better control of the power tool in unexpected situations.
- f. **Dress properly. Do not wear loose clothing or jewellery. Keep your hair, clothing and gloves away from moving parts.** Loose clothes, jewellery or long hair can be caught in moving parts.
- g. **If devices are provided for the connection of dust extraction and collection facilities, ensure these are connected and properly used.** Use of these devices can reduce dust related hazards.

**4. POWER TOOL USE AND CARE**

- a. **Do not force the power tool. Use the correct power tool for your application.** The correct power tool will do the job better and safer at the rate for which it was designed.
- b. **Do not use the power tool if the switch does not turn it on and off.** Any power tool that cannot be controlled with the switch is dangerous and must be repaired.
- c. **Disconnect the plug from the power source before making any adjustments, changing accessories, or storing power tools.** Such preventive safety measures reduce the risk of starting the power tool accidentally.
- d. **Store idle power tools out of the reach of children and do not allow persons unfamiliar with the power tool or these instructions to operate the power tool.** Power tools are dangerous in the hands of untrained users.
- e. **Maintain power tools. Check for misalignment or binding of moving parts, breakage of parts and any other condition that may affect the power tools operation. If damaged, have the power tool repaired before use.** Many accidents are caused by poorly maintained power tools.
- f. **Keep cutting tools sharp and clean.** Properly maintained cutting tools with sharp cutting edges are less likely to bind and are easier to control.
- g. **Use the power tool, accessories and tool bits etc., in accordance with these instructions and in the manner intended for the particular type of power tool, taking into account the working conditions and the work to be performed.** Use of the power tool for operations different from those intended could result in a hazardous situation.

**5. SERVICE**

- a. **Have your power tool serviced by a qualified repair person using only identical replacement parts.** This will ensure that the safety of the power tool is maintained.

**Electrical Safety**

The electric motor has been designed for one voltage only. Always check that the power supply corresponds to the voltage on the rating plate. 240 V AC means your tool will operate on alternating current. As little as 10% lower voltage can cause loss of power and can result in overheating. All DEWALT tools are factory tested; if this tool does not operate, check the power supply. Your DEWALT tool is double insulated, therefore no earth wire is required.

- **Young children and the infirm.** This appliance is not intended for use by young children or infirm persons without supervision. Young children should be supervised to ensure that they do not play with this appliance.
- **Replacement of the supply cord.** If the supply cord is damaged, it must be replaced by the manufacturer or an authorised DEWALT Service Centre in order to avoid a hazard.

**Extension Cords**

**⚠ CAUTION:** Use only extension cords that are approved by the country's Electrical Authority. Before using extension cords, inspect them for loose or exposed wires, damaged insulation and defective fittings. Replace the cord if necessary.

MINIMUM GAGE FOR CORD SETS						
For Cable length (m):	7.5	15	25	30	45	60
Use Cable with minimum rating (Amperes)						
Tool Amperes						
0 - 3.4	7.5	7.5	7.5	7.5	7.5	7.5
3.5 - 5.0	7.5	7.5	7.5	7.5	10	15
5.1 - 7.0	10	10	10	10	15	15
7.1 - 12.0	15	15	15	15	20	20
12.1 - 20.0	20	20	20	20	25	–

**Safety Warnings Common for Grinding, Sanding, Wire Brushing, and Abrasive Cutting-Off Operations:**

- a) **This power tool is intended to function as a grinder, sander, wire brush, polisher or cut-off tool. Read all safety warnings, instructions, illustrations and specifications provided with this power tool.** Failure to follow all instructions listed below may result in electric shock, fire and/or serious injury.
- b) **Operations such as polishing are not recommended to be performed with this power tool.** Operations for which the power tool was not designed may create a hazard and cause personal injury.

- c) **Do not use accessories which are not specifically designed and recommended by the tool manufacturer.** Just because the accessory can be attached to your power tool, it does not assure safe operation.
- d) **The rated speed of the accessory must be at least equal to the maximum speed marked on the power tool.** Accessories running faster than their rated speed can break and fly apart.
- e) **The outside diameter and the thickness of your accessory must be within the capacity rating of your power tool.** Incorrectly sized accessories cannot be adequately guarded or controlled.
- f) **The arbour size of wheels, flanges, backing pads or any other accessory must properly fit the spindle of the power tool.** Accessories with arbour holes that do not match the mounting hardware of the power tool will run out of balance, vibrate excessively and may cause loss of control.
- g) **Do not use a damaged accessory. Before each use inspect the accessory such as abrasive wheels for chips and cracks, backing pad for cracks, tear or excess wear, wire brush for loose or cracked wires. If power tool or accessory is dropped, inspect for damage or install an undamaged accessory. After inspecting and installing an accessory, position yourself and bystanders away from the plane of the rotating accessory and run the power tool at maximum no-load speed for one minute.** Damaged accessories will normally break apart during this test time.
- h) **Wear personal protective equipment. Depending on application, use face shield, safety goggles or safety glasses. As appropriate, wear dust mask, hearing protectors, gloves and workshop apron capable of stopping small abrasive or workpiece fragments.** The eye protection must be capable of stopping flying debris generated by various operations. The dust mask or respirator must be capable of filtrating particles generated by your operation. Prolonged exposure to high intensity noise may cause hearing loss.
- i) **Keep bystanders a safe distance away from work area. Anyone entering the work area must wear personal protective equipment.** Fragments of workpiece or of a broken accessory may fly away and cause injury beyond immediate area of operation.
- j) **Hold power tool by insulated gripping surfaces only, when performing an operation where the cutting accessory may contact hidden wiring or its own cord.** Cutting accessory contacting a "live" wire may make exposed metal parts of the power tool "live" and shock the operator.
- k) **Position the cord clear of the spinning accessory.** If you lose control, the cord may be cut or snagged and your hand or arm may be pulled into the spinning accessory.
- l) **Never lay the power tool down until the accessory has come to a complete stop.** The spinning accessory may grab the surface and pull the power tool out of your control.
- m) **Do not run the power tool while carrying it at your side.** Accidental contact with the spinning accessory could snag your clothing, pulling the accessory into your body.
- n) **Regularly clean the power tool's air vents.** The motor's fan will draw the dust inside the housing and excessive accumulation of powdered metal may cause electrical hazards.
- o) **Do not operate the power tool near flammable materials.** Sparks could ignite these materials.
- p) **Do not use accessories that require liquid coolants.** Using water or other liquid coolants may result in electrocution or shock.

### ***Kickback and Related Warnings***

**Kickback is a sudden reaction to a pinched or snagged rotating wheel, backing pad, brush or any other accessory. Pinching or snagging causes rapid stalling of the rotating accessory which in turn causes the uncontrolled power tool to be forced in the direction opposite of the accessory's rotation at the point of the binding.**

**For example, if an abrasive wheel is snagged or pinched by the workpiece, the edge of the wheel that is entering into the pinch point can dig into the surface of the material causing the wheel to climb out or kick out. The wheel may either jump toward or away from the operator, depending on direction of the wheel's movement at the point of pinching. Abrasive wheels may also break under these conditions.**

**Kickback is the result of power tool misuse and/or incorrect operating procedures or conditions and can be avoided by taking proper precautions as given below.**

- a) **Maintain a firm grip on the power tool and position your body and arm to allow you to resist kickback forces. Always use auxiliary handle, if provided, for maximum control over kickback or torque reaction during start-up.** The operator can control torque reactions or kickback forces, if proper precautions are taken.

- b) **Never place your hand near the rotating accessory.** Accessory may kickback over your hand.
- c) **Do not position your body in the area where power tool will move if kickback occurs.** Kickback will propel the tool in direction opposite to the wheel's movement at the point of snagging.
- d) **Use special care when working corners, sharp edges etc. Avoid bouncing and snagging the accessory.** Corners, sharp edges or bouncing have a tendency to snag the rotating accessory and cause loss of control or kickback.
- e) **Do not attach a saw chain woodcarving blade or toothed saw blade.** Such blades create frequent kickback and loss of control.

***Safety Warnings Specific for Grinding and Abrasive Cutting-Off Operations:***

- a) **Use only wheel types that are recommended for your power tool and the specific guard designed for the selected wheel.** Wheels for which the power tool was not designed cannot be adequately guarded and are unsafe.
- b) **The guard must be securely attached to the power tool and positioned for maximum safety, so the least amount of wheel is exposed towards the operator.** The guard helps to protect operator from broken wheel fragments and accidental contact with wheel.
- c) **Wheels must be used only for recommended applications. For example: do not grind with the side of cut-off wheel.** Abrasive cut-off wheels are intended for peripheral grinding, side forces applied to these wheels may cause them to shatter.
- d) **Always use undamaged wheel flanges that are of correct size and shape for your selected wheel.** Proper wheel flanges support the wheel thus reducing the possibility of wheel breakage. Flanges for cut-off wheels may be different from grinding wheel flanges.
- e) **Do not use worn down wheels from larger power tools.** Wheel intended for larger power tool is not suitable for the higher speed of a smaller tool and may burst.

***Additional Safety Warnings Specific for Abrasive Cutting-Off Operations:***

- a) **Do not "jam" the cut-off wheel or apply excessive pressure. Do not attempt to make an excessive depth of cut.** Overstressing the wheel increases the loading and susceptibility to twisting or binding of the wheel in the cut and the possibility of kickback or wheel breakage.

- b) **Do not position your body in line with and behind the rotating wheel.** When the wheel, at the point of operation, is moving away from your body, the possible kickback may propel the spinning wheel and the power tool directly at you.
- c) **When wheel is binding or when interrupting a cut for any reason, switch off the power tool and hold the power tool motionless until the wheel comes to a complete stop. Never attempt to remove the cut-off wheel from the cut while the wheel is in motion otherwise kickback may occur.** Investigate and take corrective action to eliminate the cause of wheel binding.
- d) **Do not restart the cutting operation in the workpiece. Let the wheel reach full speed and carefully reenter the cut.** The wheel may bind, walk up or kickback if the power tool is restarted in the workpiece.
- e) **Support panels or any oversized workpiece to minimize the risk of wheel pinching and kickback.** Large workpieces tend to sag under their own weight. Supports must be placed under the workpiece near the line of cut and near the edge of the workpiece on both sides of the wheel.
- f) Use extra caution when making a "pocket cut" into existing walls or other blind areas. The protruding wheel may cut gas or water pipes, electrical wiring or objects that can cause kickback.

***Safety Warnings Specific for Sanding Operations:***

- a) **Do not use excessively oversized sanding disc paper. Follow manufacturers recommendations, when selecting sanding paper.** Larger sanding paper extending beyond the sanding pad presents a laceration hazard and may cause snagging, tearing of the disc or kickback.

***Safety Warnings Specific for Wire Brushing Operations:***

- a) **Be aware that wire bristles are thrown by the brush even during ordinary operation. Do not overstress the wires by applying excessive load to the brush.** The wire bristles can easily penetrate light clothing and/or skin.
- b) **If the use of a guard is recommended for wire brushing, do not allow any interference of the wire wheel or brush with the guard.** Wire wheel or brush may expand in diameter due to work load and centrifugal forces.

***Additional Safety Instructions***

- Check that the grinding wheel backing flange has a yellow rubber ring (F) installed, see Figure 1. Replace rubber ring if missing, damaged or worn. See page 5 for details regarding proper accessory installation.

**⚠️ WARNING: The grinding wheel or accessory may loosen during coast-down of the tool when shut off if rubber ring is missing or damaged.** If grinding wheel or accessory loosens, it may dismount from the machine and may cause serious personal injury.

- **Always use proper guard with grinding wheel.** A guard protects operator from broken wheel fragments and wheel contact.
- **Accessories must be rated for at least the speed recommended on the tool warning label.** Wheels and other accessories running over rated speed can fly apart and cause injury. Accessory ratings must be above listed minimum wheel speed as shown on tool nameplate.
- **Hold tool by insulated gripping surfaces when performing an operation where the cutting tool may contact hidden wiring or its own cord.** Contact with a “live” wire will make exposed metal parts of the tool “live” and shock the operator.
- **Do not use Type 11 (flaring cup) wheels on this tool.** Using inappropriate accessories can result in injury.
- **ALWAYS WEAR EYE PROTECTION WHEN USING THIS TOOL.**
- **Use of accessories not specified in this manual is not recommended and may be hazardous.** Use of power boosters that would cause the tool to be driven at speeds greater than its rated speed constitutes misuse.
- **Do not use circular saw blades or any other toothed blades with this tool.** Serious injury may result.
- **When starting the tool with a new or replacement wheel, or a new or replacement wire brush installed, hold the tool in a well protected area and let it run for one minute.** If the wheel has an undetected crack or flaw, it should burst in less than one minute. If the wire brush has loose wires, they will be detected. Never start the tool with a person in line with the wheel. This includes the operator.
- **Avoid bouncing the wheel or giving it rough treatment.** If this occurs, stop the tool and inspect the wheel for cracks or flaws.
- **Direct sparks away from operator, bystanders or flammable materials.** Sparks may be produced while cutting and/or grinding. Sparks may cause burns or start fires.
- **Always use side handle. Tighten the handle securely.** The side handle should always be used to maintain control of the tool at all times.

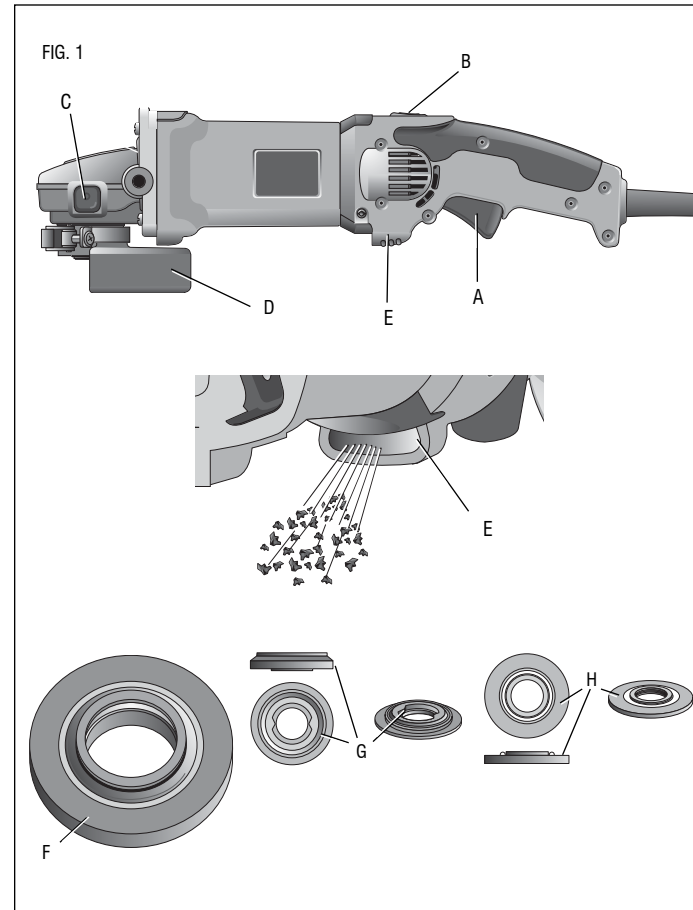

- **Never cut into area that may contain electrical wiring or piping.** Serious injury may result.
- **Clean out your tool often, especially after heavy use.** Dust and grit containing metal particles often accumulate on interior surfaces and could create an electric shock hazard.
- **Do not operate this tool for long periods of time.** Vibration caused by the operating action of this tool may cause permanent injury to fingers, hands, and arms. Use gloves to provide extra cushion, take frequent rest periods, and limit daily time of use.
- **Direct the Dust Ejection System™ away from operator and coworkers.** Serious injury may result (Fig. 1, K).
- The label on your tool may include the following symbols. The symbols and their definitions are as follows:
 

V..... volts	A .....amperes
Hz ..... hertz	W .....watts
min ..... minutes	~ .....alternating current
==== ..... direct current	n <sub>0</sub> .....no load speed
Ⓛ ..... Class I Construction (grounded)	⊕ .....earthing terminal
□ ..... Class II Construction (double insulated)	⚠ .....safety alert symbol
BPM.....beats per minute	.../min.....revolutions or reciprocation per minute

### ***Causes and Operator Prevention of Kickback***

- Kickback is a sudden reaction to a pinched, bound or misaligned wheel, wire brush or flap disc causing an uncontrolled cut-off tool to lift up and out of the workpiece toward the operator.
- When the wheel is pinched or bound tightly by the workpiece, the wheel stalls and the motor reaction drives the unit rapidly back toward or away from the operator.
- Kickback is the result of tool misuse and/or incorrect operating procedures or conditions and can be avoided by taking proper precautions as given below:
- **Maintain a firm grip with both hands on the unit and position your body and arm to allow you to resist kickback forces.** Kickback forces can be controlled by the operator, if proper precautions are taken.

- **When wheel is binding, or when interrupting a cut for any reason, release the trigger and hold the unit motionless in the material until the wheel comes to a complete stop. Never attempt to remove the unit from the work or pull the unit backward while the wheel is in motion or kickback may occur.** Investigate and take corrective actions to eliminate the cause of wheel binding.
- **When restarting a cut-off accessory in the workpiece, check that the wheel is not engaged into the material.** If wheel is binding, it may walk up or kickback from the workpiece as the tool is restarted.
- **Support large panels to minimize the risk of wheel pinching and kickback.** Large panels tend to sag under their own weight. Support must be placed under the panel on both sides, near the line of cut and near the edge of the panel.

**⚠ WARNING: ALWAYS** use safety glasses. Everyday eyeglasses are NOT safety glasses. Also use face or dust mask if cutting operation is dusty. **ALWAYS WEAR CERTIFIED SAFETY EQUIPMENT:**

- ANSI Z87.1 eye protection (CAN/CSA Z94.3),
- ANSI S12.6 (S3.19) hearing protection,
- NIOSH/OSHA/MSHA respiratory protection.

**⚠ WARNING: Always wear proper personal hearing protection that conforms to ANSI S12.6 (S3.19) during use.** Under some conditions and duration of use, noise from this product may contribute to hearing loss.

**⚠ WARNING: Always use eye protection.** All users and bystanders must wear eye protection that conforms to ANSI Z87.1.

**⚠ WARNING:** Some dust created by power sanding, sawing, grinding, drilling, and other construction activities contains chemicals known to cause cancer, birth defects, or other reproductive harm. Some examples of these chemicals are:

- lead from lead-based paints,
- crystalline silica from bricks and cement and other masonry products, and
- arsenic and chromium from chemically-treated lumber (CCA).

Your risk from these exposures varies, depending on how often you do this type of work. To reduce your exposure to these chemicals: work in a well ventilated area, and work with approved safety equipment, such as those dust masks that are specially designed to filter out microscopic particles.

- **Avoid prolonged contact with dust from power sanding, sawing, grinding, drilling, and other construction activities. Wear protective clothing and wash exposed areas with soap and water.** Allowing dust to get into your mouth, eyes, or lay on the skin may promote absorption of harmful chemicals.



**125 mm (5") Grinding Wheels**

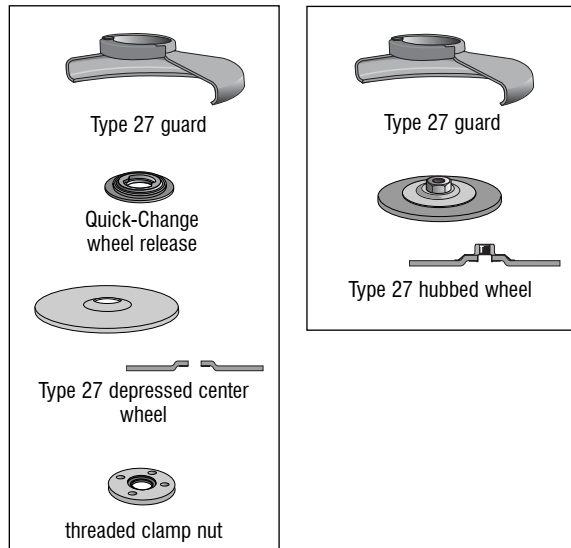

**125 mm (5") Cutting Wheels**

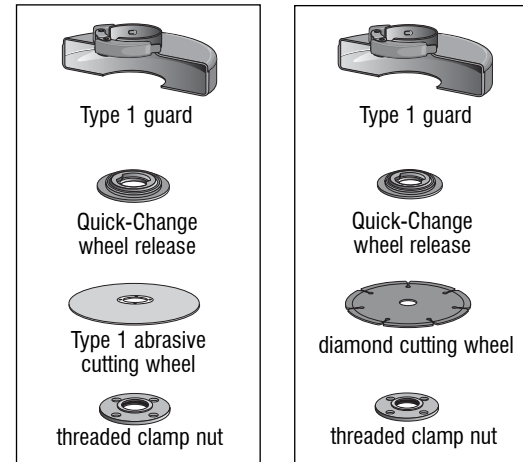

**Wire Wheels**

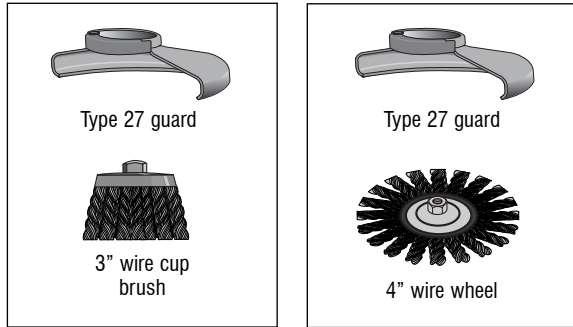

**125 mm (5") Sanding Flap Discs**

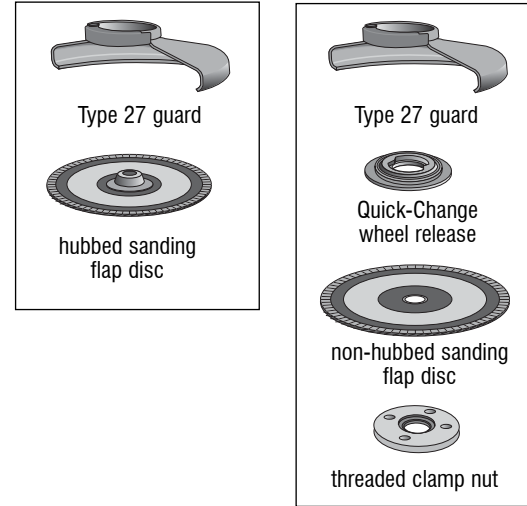

**Sanding Discs**

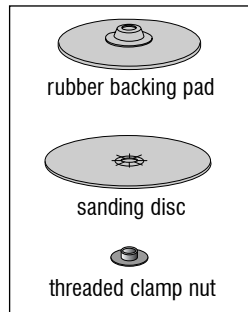

**⚠ WARNING:** Use of this tool can generate and/or disburse dust, which may cause serious and permanent respiratory or other injury. Always use NIOSH/OSHA approved respiratory protection appropriate for the dust exposure. Direct particles away from face and body.

**⚠ CAUTION:** Use extra care when working into a corner because a sudden, sharp movement of the grinder may be experienced when the wheel or other accessory contacts a secondary surface or a surface edge.

### COMPONENTS (Fig. 1)

**⚠ WARNING:** Never modify the power tool or any part of it. Damage or personal injury could result.

- |                          |   |
|--------------------------|---|
| A. Trigger Switch        | F. Yellow Rubber Ring                     |
| B. Lock Off Button       | G. Quick-Change Wheel Release             |
| C. Spindle Lock Button   | H. Threaded Clamp Nut                     |
| D. Type 27 Guard         | I. Anti-Vibration Side Handle (not shown) |
| E. Dust Ejection System™ |   |

### INTENDED USE

The D28065, D26065N, D28115, D28115N heavy-duty angle grinders have been designed for professional grinding at various work sites (i.e., construction sites). **DO NOT** use under wet conditions or in presence of flammable liquids or gases.

These heavy-duty angle grinders are professional power tools. **DO NOT** let children come into contact with the tool. Supervision is required when inexperienced operators use this tool.

### ASSEMBLY AND ADJUSTMENTS

#### ATTACHING SIDE HANDLE

The side handle (I) can be fitted to either side of the gear case in the threaded holes, as shown. Before using the tool, check that the handle is tightened securely. Use a wrench to firmly tighten the side handle.

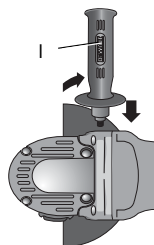

### Rotating the Gear Case

**⚠ WARNING:** To reduce the risk of serious personal injury, turn tool off and disconnect tool from power source before making any adjustments or removing/installing attachments or accessories.

1. Remove guard and flanges from tool.
2. Remove the four corner screws attaching the gear case to motor housing.
3. Separating the gear case from motor housing not more than 6.35 mm (1/4"), rotate the gear case head to desired position.

**NOTE:** If the gear case and motor housing become separated by more than 6.35 mm (1/4"), the tool must be serviced and re-assembled by a DeWALT service center. Failure to have the tool serviced may cause brush, motor and bearing failure.

4. Re-install screws to attach the gear case to the motor housing. Tighten screws to 18 in./lbs. torque. Overtightening could cause screws to strip.
5. Re-install guard and correct flanges for the appropriate accessories.

### Accessories

It is important to choose the correct guards, backing pads and flanges to use with grinder accessories. See pages 7–8 for information on choosing the correct accessories.

**⚠ WARNING:** Accessories must be rated for at least the speed recommended on the tool warning label. Wheels and other accessories running over rated accessory speed may burst and cause injury. Threaded accessories must have a 14mm hub. Every unthreaded accessory must have a 22.2 mm (7/8") arbor hole. If it does not, it may have been designed for a circular saw and should not be used. Use only the accessories shown on pages 7–8 of this manual. Accessory ratings must be above listed minimum wheel speed as shown on tool nameplate.

### Mounting Guard

#### MOUNTING AND REMOVING GUARD

**⚠ WARNING:** To reduce the risk of serious personal injury, turn tool off and disconnect tool from power source before making any adjustments or removing/installing attachments or accessories.

**⚠ CAUTION:** Guards must be used with all grinding wheels, sanding flap discs, wire brushes, and wire wheels. The tool may be used without a guard only when sanding with conventional sanding discs. Some DEWALT models are provided with a guard intended for use with depressed center wheels (Type 27) and hubbed grinding wheels (Type 27). The same guard is designed for use with sanding flap discs (Type 27 and 29) and wire brushes. Grinding and cutting with wheels other than Type 27 and 29 require different accessory guards not included with tool. Mounting instructions for these accessory guards are included in the accessory package.

1. Open the guard latch (J). Align the lugs (K) on the guard with the slots (L) on the gear case.
2. Push the guard down until the guard lugs engage and rotate freely in the groove on the gear case hub.
3. With the guard latch open, rotate the guard (D) into the desired working position. The guard body should be positioned between the spindle and the operator to provide maximum operator protection.
4. Close the guard latch to secure the guard on the gear case. You should not be able to rotate the guard by hand when the latch is closed. Do not operate the grinder with a loose guard or the clamp lever in open position.
5. To remove the guard, open the guard latch, rotate the guard so that the arrows are aligned and pull up on the guard.

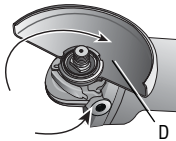
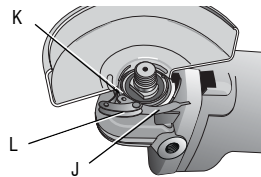

**NOTE:** The guard is pre-adjusted to the diameter of the gear case hub at the factory. If, after a period of time, the guard becomes loose, tighten the adjusting screw (M) with clamp lever in the closed position.

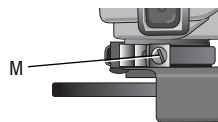

**⚠ CAUTION:** Do not tighten the adjusting screw with the clamp lever in open position. Undetectable damage to the guard or the mounting hub may result.

**⚠ CAUTION:** If guard cannot be tightened by adjusting clamp, do not use tool and take the tool and guard to a service center to repair or replace the guard.

## OPERATION

**⚠ WARNING:** To reduce the risk of serious personal injury, turn tool off and disconnect tool from power source before making any adjustments or removing/installing attachments or accessories.

### Guards and Flanges

It is important to choose the correct guards and flanges to use with the grinder accessories. See pages 7–8 for the correct accessories.

**NOTE:** Edge grinding and cutting can be performed with Type 27 wheels designed and specified for this purpose.

**⚠ WARNING:** Accessories must be rated for at least the speed recommended on the tool warning label. Wheels and other accessories running over rated accessory speed may burst and cause injury. Every unthreaded accessory must have a 22.2 mm (7/8") arbor hole. If it does not, it may have been designed for a circular saw and should not be used. Use only the accessories shown on pages 7–8. Accessory ratings must be above listed minimum wheel speed as shown on tool nameplate.

### Trigger Switch (Fig. 1)

**⚠ CAUTION:** Hold the side handle and body of the tool firmly to maintain control of the tool at start up and during use and until the wheel or accessory stops rotating. Make sure the wheel has come to a complete stop before laying the tool down.

**NOTE:** To reduce unexpected tool movement, do not switch the tool on or off while under load conditions. Allow the grinder to run up to full speed before touching the work surface. Lift the tool from the surface before turning the tool off. Allow the tool to stop rotating before putting it down.

To turn the tool on, depress the trigger switch (A) while depressing the lock-off button (B). Once the tool is running, the lock off button (B) can be released. The tool will run while the switch is depressed. Turn the tool off by releasing the trigger switch.

**⚠ CAUTION:** Allow the tool to reach full speed before touching tool to the work surface. Lift the tool from the work surface before turning the tool off.

### SPINDLE LOCK

The spindle lock (C) is provided to prevent the spindle from rotating when installing or removing wheels. Operate the spindle lock only when the tool is

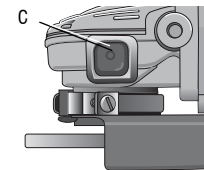

turned off, unplugged from the power supply, and has come to a complete stop. Do not engage the spindle lock while the tool is operating because damage to the tool will result.

To engage the lock, depress the spindle lock button and rotate the spindle until you are unable to rotate the spindle further.

### Mounting and Using Depressed Center Grinding Wheels and Sanding Flap Discs

#### MOUNTING AND REMOVING HUBBED WHEELS

**⚠ WARNING:** To reduce the risk of serious personal injury, turn tool off and disconnect tool from power source before making any adjustments or removing/installing attachments or accessories.

Hubbed wheels install directly on the 14m2 threaded spindle. Thread of accessory must match thread of spindle.

1. Backing flange is retained to the grinder by an o-ring on the spindle. Remove backing flange by pulling and twisting flange away from the machine.
2. Thread the wheel on the spindle by hand.
3. Depress the spindle lock button and use a wrench to tighten the hub of the wheel.
4. Reverse the above procedure to remove the wheel.

**⚠ CAUTION:** Failure to properly seat the wheel before turning the tool on may result in damage to the tool or the wheel.

#### MOUNTING NON-HUBBED WHEELS

**⚠ WARNING:** To reduce the risk of serious personal injury, turn tool off and disconnect tool from power source before making any adjustments or removing/installing attachments or accessories.

Depressed center Type 27 grinding wheels must be used with included flanges.

1. Install the unthreaded backing flange (G) on spindle (N) with the raised section (pilot) against the wheel. Be sure the backing flange recess is seated onto the flats of the spindle by pushing and twisting the flange before placing wheel.

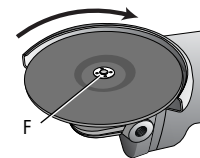
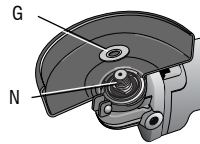

2. Place wheel against the backing flange, centering the wheel on the raised section (pilot) of the backing flange.

3. While depressing the spindle lock button, thread the clamp nut (H) on spindle. If the wheel you are installing is more than 3.31 mm (1/8") thick, place the threaded clamp nut on the spindle so that the raised section (pilot) fits into the center of the wheel. If the wheel you are installing is 3.31 mm (1/8") thick or less, place the threaded clamp nut on the spindle so that the raised section (pilot) is not against the wheel.

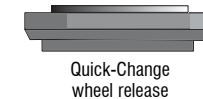
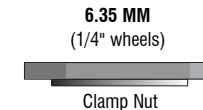

4. While depressing the spindle lock button, tighten the clamp nut with a wrench.

5. To remove the wheel, depress the spindle lock button and loosen the threaded clamp nut with a wrench.

**NOTE:** If the wheel spins after the clamp nut is tightened, check the orientation of the threaded clamp nut. If a thin wheel is installed with the pilot on the clamp nut against the wheel, it will spin because the height of the pilot prevents the clamp nut from holding the wheel.

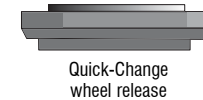
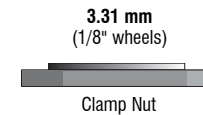

#### SURFACE GRINDING WITH GRINDING WHEELS

1. Allow the tool to reach full speed before touching the tool to the work surface.
2. Apply minimum pressure to the work surface, allowing the tool to operate at high speed. Grinding rate is greatest when the tool operates at high speed.
3. Maintain a 20° to 30° angle between the tool and work surface.
4. Continuously move the tool in a forward and back motion to avoid creating gouges in the work surface.
5. Remove the tool from work surface before turning tool off. Allow the tool to stop rotating before laying it down.

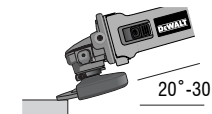

### EDGE GRINDING WITH GRINDING WHEELS

**⚠ CAUTION:** Wheels used for cutting and edge grinding may break if they bend or twist while the tool is being used to do cut-off work or deep grinding. To reduce the risk of serious injury, limit the use of these wheels with a standard Type 27 guard to shallow cutting and notching [less than 12.7 mm (1/2") in depth]. The open side of the guard must be positioned away from the operator. For deeper cutting with a Type 1 cut-off wheel, use a closed, Type 1 guard. See the chart on page 7 and 8 for more information. Type 1 guards are available at extra cost from your local dealer or authorized service center.

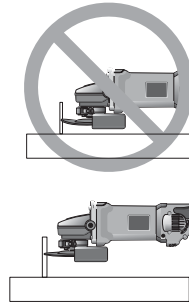

1. Allow the tool to reach full speed before touching the tool to the work surface.
2. Apply minimum pressure to the work surface, allowing the tool to operate at high speed. Grinding rate is greatest when the tool operates at high speed.
3. Position yourself so that the open-underside of the wheel is facing away from you.
4. Once a cut is begun and a notch is established in the workpiece, do not change the angle of the cut. Changing the angle will cause the wheel to bend and may cause wheel breakage. Edge grinding wheels are not designed to withstand side pressures caused by bending.
5. Remove the tool from the work surface before turning the tool off. Allow the tool to stop rotating before laying it down.

**⚠ WARNING:** Do not use edge grinding/cutting wheels for surface grinding applications because these wheels are not designed for side pressures encountered with surface grinding. Wheel breakage and injury may result.

### SURFACE FINISHING WITH SANDING FLAP DISCS

1. Allow the tool to reach full speed before touching the tool to the work surface.
2. Apply minimum pressure to work surface, allowing the tool to operate at high speed. Sanding rate is greatest when the tool operates at high speed.
3. Maintain a 5° to 10° angle between the tool and work surface.
4. Continuously move the tool in a forward and back motion to avoid creating gouges in the work surface.

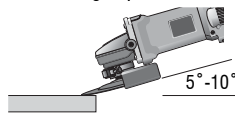

5. Remove the tool from work surface before turning tool off. Allow the tool to stop rotating before laying it down.

### MOUNTING SANDING BACKING PADS

**⚠ WARNING:** To reduce the risk of serious personal injury, turn tool off and disconnect tool from power source before making any adjustments or removing/installing attachments or accessories.

**⚠ CAUTION:** Proper guard must be reinstalled for grinding wheel, sanding flap disc, wire brush or wire wheel applications after sanding applications are complete.

1. Place or appropriately thread backing pad (O) on the spindle.
2. Place the sanding disc (P) on the backing pad.
3. While depressing spindle lock, thread clamp nut (H) on spindle, piloting the raised hub on the clamp nut into the center of sanding disc and backing pad.
4. Tighten the clamp nut by hand. Then depress the spindle lock button while turning the sanding disc until the sanding disc and clamp nut are snug.
5. To remove the wheel, grasp and turn the backing pad and sanding pad while depressing the spindle lock button.

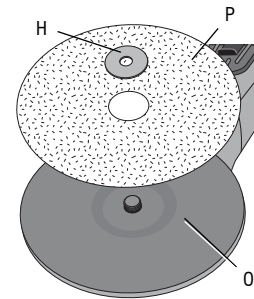

### USING SANDING BACKING PADS

Choose the proper grit sandpaper for your application. Sandpaper is available in various grits. Coarse grits yield faster material removal rates and a rougher finish. Finer grits yield slower material removal and a smoother finish.

Begin with coarse grit discs for fast, rough material removal. Move to a medium grit paper and finish with a fine grit disc for optimal finish.

Coarse	16 - 30 grit
Medium	36 - 80 grit
Fine Finishing	100 - 120 grit
Very Fine Finishing	150 - 180 grit

1. Allow the tool to reach full speed before touching tool to the work surface.
2. Apply minimum pressure to work surface, allowing the tool to operate at high speed. Sanding rate is greatest when the tool operates at high speed.

3. Maintain a 5° to 15° angle between the tool and work surface. The sanding disc should contact approximately one inch of work surface.

4. Move the tool constantly in a straight line to prevent burning and swirling of work surface. Allowing the tool to rest on the work surface without moving, or moving the tool in a circular motion causes burning and swirling marks on the work surface.

5. Remove the tool from work surface before turning tool off. Allow the tool to stop rotating before laying it down.

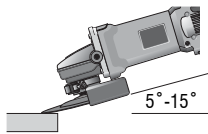

### **Mounting and Using Wire Brushes and Wire Wheels**

Wire cup brushes or wire wheels screw directly on the grinder spindle without the use of flanges. Use only wire brushes or wheels provided with a 14m2 threaded hub. A Type 27 guard is required when using wire brushes and wheels.

**⚠ CAUTION:** Wear work gloves when handling wire brushes and wheels. They can become sharp.

**⚠ CAUTION:** Wheel or brush must not touch guard when mounted or while in use. Undetectable damage could occur to the accessory, causing wires to fragment from accessory wheel or cup.

#### **MOUNTING WIRE BRUSHES AND WIRE WHEELS**

**⚠ WARNING:** To reduce the risk of serious personal injury, turn tool off and disconnect tool from power source before making any adjustments or removing/installing attachments or accessories.

1. Thread the wheel on the spindle by hand.
2. Depress spindle lock button and use a wrench on the hub of the wire wheel or brush to tighten the wheel.
3. To remove the wheel, reverse the above procedure.

**⚠ CAUTION:** Failure to properly seat the wheel hub before turning the tool on may result in damage to tool or wheel.

#### **USING WIRE CUP BRUSHES AND WIRE WHEELS**

Wire wheels and brushes can be used for removing rust, scale and paint, and for smoothing irregular surfaces.

1. Allow the tool to reach full speed before touching the tool to the work surface.

2. Apply minimum pressure to work surface, allowing the tool to operate at high speed. Material removal rate is greatest when the tool operates at high speed.

3. Maintain a 5° to 10° angle between the tool and work surface for wire cup brushes.

4. Maintain contact between the edge of the wheel and the work surface with wire wheels.

5. Continuous move the tool in a forward and back motion to avoid creating gouges in the work surface. Allowing the tool to rest on the work surface without moving, or moving the tool in a circular motion causes burning and swirling marks on the work surface.

6. Remove the tool from the work surface before turning the tool off. Allow the tool to stop rotating before setting it down.

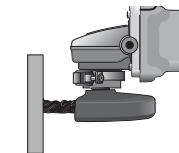
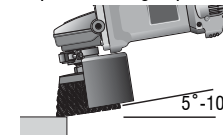

**⚠ CAUTION:** Use extra care when working over an edge, as a sudden sharp movement of grinder may be experienced.

### **Mounting and Using Cutting (Type 1) Wheels**

Cutting wheels include diamond wheels and abrasive discs. Abrasive cutting wheels for metal and concrete use are available. Diamond blades for concrete cutting can also be used.

**NOTE:** All grinders that use Type 1 wheels use the quick change wheel release (G).

**⚠ WARNING:** A closed, 2-sided cutting wheel guard is not included with this tool and is required when using cutting wheels. Failure to use proper flange and guard can result in injury resulting from wheel breakage and wheel contact. See page 8 for more information.

#### **MOUNTING CLOSED (TYPE 1) GUARD**

**⚠ WARNING:** To reduce the risk of serious personal injury, turn tool off and disconnect tool from power source before making any adjustments or removing/installing attachments or accessories.

1. Open the guard latch (J). Align the lugs (K) on the guard with the slots (L) on the gear case.

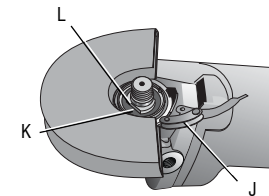

2. Push the guard down until the guard lug engages and rotates freely in the groove on the gear case hub.
3. Rotate guard (D) into desired working position. The guard body should be positioned between the spindle and the operator to provide maximum operator protection.
4. Close the guard latch to secure the guard on the gear case cover. You should be unable to rotate the guard by hand when the latch is in closed position. If rotation is possible, tighten the adjusting screw (M) with clamp lever in the closed position. Do not operate grinder with a loose guard or clamp lever in open position.
5. To remove the guard, open the guard latch, rotate the guard so that the arrows are aligned and pull up on the guard.

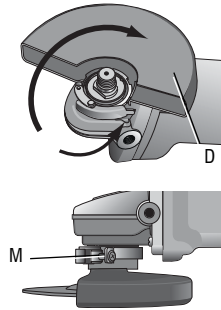

**NOTE:** If, after a period of time, the guard becomes loose, tighten the adjusting screw (M) with the clamp lever in the closed position.

**CAUTION:** Do not tighten adjusting screw with clamp lever in open position. Undetectable damage to guard or mounting hub may result.

#### MOUNTING CUTTING WHEELS

**CAUTION:** Turn off and unplug the tool before making any adjustments or removing or installing attachments or accessories. Before reconnecting the tool, turn the switch on and off as previously described to ensure that the tool is off.

**CAUTION:** Matching diameter threaded backing flange and clamp nut (included with tool) must be used for cutting wheels.

1. Place the unthreaded backing flange on spindle with the raised section (pilot) facing up. The raised section (pilot) on the backing flange will be against the wheel when the wheel is installed.
2. Place the wheel on the backing flange, centering the wheel on the raised section (pilot).

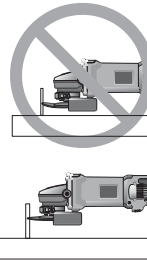

3. Install the threaded clamp nut with the raised section (pilot) facing away from the wheel.
4. Depress the spindle lock button and tighten clamp nut with a wrench.
5. To remove the wheel, grasp and turn while depressing the spindle lock button.

#### USING CUTTING WHEELS

**WARNING:** Do not use edge grinding/ cutting wheels for surface grinding applications because these wheels are not designed for side pressures encountered with surface grinding. Wheel breakage and injury may result.

1. Allow tool to reach full speed before touching tool to work surface.
2. Apply minimum pressure to work surface, allowing tool to operate at high speed. Cutting rate is greatest when the tool operates at high speed.
3. Once a cut is begun and a notch is established in the workpiece, do not change the angle of the cut. Changing the angle will cause the wheel to bend and may cause wheel breakage.
4. Remove the tool from work surface before turning tool off. Allow the tool to stop rotating before setting it down.

#### MAINTENANCE

**WARNING:** To reduce the risk of serious personal injury, turn tool off and disconnect tool from power source before making any adjustments or removing/ installing attachments or accessories.

#### Cleaning

**WARNING:** Blowing dust and grit out of motor and switch actuator using clean, dry compressed air is a necessary regular maintenance procedure. Dust and grit containing metal particles often accumulate on interior surfaces and could create an electrical shock or electrocution if not frequently cleaned out. It is recommended that a ground fault circuit interrupter (GFCI) is utilized to further protect the user from electric shock resulting from the accumulation of conductive particles. If the tool is deactivated by the GFCI, unplug the tool and check and clean the tool before resetting the GFCI. ALWAYS WEAR SAFETY GLASSES when cleaning or using this tool.

**CAUTION:** Never use solvents or other harsh chemicals for cleaning the non-metallic parts of the tool. Use a clean, dry cloth only. Never let any liquid get inside the tool; never immerse any part of the tool into a liquid.



### **Lubrication**

DeWALT tools are properly lubricated at the factory and are ready for use.

### **Repairs**

To assure product SAFETY and RELIABILITY, repairs, maintenance and adjustment (including brush inspection and replacement) should be performed by certified service centers or other qualified service organizations, always using identical replacement parts.

### **Accessories**

**⚠ WARNING:** Since accessories, other than those offered by DeWALT, have not been tested with this product, use of such accessories with this tool could be hazardous. To reduce the risk of injury, only DeWALT, recommended accessories should be used with this product.

Recommended accessories for use with your tool are available at extra cost from your local service center. If you need any assistance in locating any accessory, please contact DeWALT Industrial Tool Co., 20 Fletcher Road, Mooroolbark, VIC 3138; 1800 654 155 or DeWALT Industrial Tool Co., 5 Te Apunga Place, Mt. Wellington, New Zealand; 09 259 1111.

### **Guarantee**

Applicable to hand held Power Tools, Lasers and Nailers.

### **Three Year Limited Warranty**

DeWALT will repair, without charge, any defects due to faulty materials or workmanship for three years from the date of purchase. Please return the complete unit, transportation prepaid, to any DeWALT Service Centre, or any authorised service station.

For warranty repair information, call (AUS) 1800 654 155 or (NZ) 09 259 1111.

This warranty does not apply to

- Accessories
- Damage caused where repairs have been made or attempted by others.
- Damage due to misuse, neglect, wear and tear, alteration or modification.

This warranty gives you specific legal rights and you may have other rights under the provisions of the Consumer Guarantee Act 1993 (New Zealand only), Trade Practices Act 1974 and State Legislation (Australia only).

In addition to the warranty, DeWALT tools are covered by our:

### **FREE ONE YEAR SERVICE CONTRACT**

DeWALT will also maintain the tool for free at any time during the first year of purchase. This includes labour, parts and lubrication required to restore the product to sound mechanical and/or electrical condition. Normal wear parts are not covered in this service. Carbon brushes worn more than 50% will be replaced.

**NOTE:** Three Year Warranty is not applicable to items deemed as consumables. Radial arm saws are covered by a one (1) year warranty only. DeWALT Reserves the right to review its warranty policy prior to launch of any new business development products.

### **30 DAY NO SATISFACTION GUARANTEE**

If you are dissatisfied with any DeWALT power tool, laser or nailer, for any reason, simply return it to the point of purchase with your sales receipt within 30 days for a replacement unit or a full refund.

**FREE WARNING LABEL REPLACEMENT:** If your warning labels become illegible or are missing, call (AUS) 1800 654 155 or (NZ) 09 259 1111 for a free replacement.

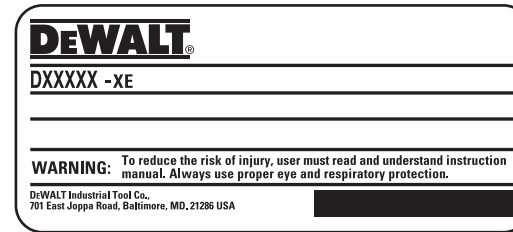





DeWALT Industrial Tool Co.,  
20 Fletcher Road, Mooroolbark, VIC 3138 Australia (03 8720 5100) • 5 Te Apunga Place, Mt Wellington, New Zealand (09 259 1111)  
(JUL07) Form No. 647789-00 D28065-XE, D28065N-XE, D28115-XE, D28115N-XE Copyright © 2007 DeWALT

The following are trademarks for one or more DeWALT power tools: the yellow and black color scheme; the "D" shaped air intake grill; the array of pyramids on the handgrip; the kit box configuration; and the array of lozenge-shaped humps on the surface of the tool.